



basically trade[®]

BESPOKE KITCHEN & BEDROOM MANUFACTURER

Trade Brochure

“
**Quality means
doing it right
when no one
is looking**”
”

Henry Ford

MANUFACTURING BESPOKE
KITCHENS AND BEDROOMS WITH
PASSION, CARE, CRAFTSMANSHIP
AND DEDICATION



FSG Kunststoff-Cleaner, Typ DN

1.000 ml

! Achtung! Enthält aggressive Substanzen und
Korrosionsmittel. Kann Haut und Schleimhäute
schädigen. Auch geeignet zum Reinigen von
Küchen. Bei Kontakt mit Haut: Sofort
mit viel Wasser abwaschen. Bei Kontakt mit
den Augen: Sofort mit viel Wasser abwaschen.
Sonnenschutz für die Augen erforderlich.



Gefahr

! Achtung! Enthält aggressive Substanzen und
Korrosionsmittel. Kann Haut und Schleimhäute
schädigen. Auch geeignet zum Reinigen von
Küchen. Bei Kontakt mit Haut: Sofort
mit viel Wasser abwaschen. Bei Kontakt mit
den Augen: Sofort mit viel Wasser abwaschen.
Sonnenschutz für die Augen erforderlich.

Contents

Kitchen Carcasses

| | |
|---------------------------------|---------|
| ● Hiline Base Units | 10 |
| ● Drawerline Base Units | 11 - 12 |
| ● Drawer Base Units | 14 |
| ● Low Level Base Units | 14 |
| ● Oven and Microwave Base Units | 15 |
| ● Belfast Sink Base Units | 16 |
| ● Base Open Units | 16 |
| ● Base Tall Open Units | 16 |
| ● Small Wall Units (575 high) | 17 |
| ● Medium Wall Units (720 high) | 19 |
| ● Tall Wall Units (900 high) | 20 |
| ● Top Boxes | 21 |
| ● Small Dressers (1065 high) | 21 |
| ● Medium Dressers (1210 high) | 22 |
| ● Tall Dressers (1390 high) | 22 |
| ● Fridge / Freezer Housings | 23 |
| ● Oven Housings | 24 - 25 |
| ● Miscellaneous Tall Units | 25 |
| ● Accessory Panels | 27 |

We manufacture for any room in the house, to your exact specification.

Business requirements?

We've manufactured for bars, boutiques, bistros and more.

Bedroom Carcasses

| | |
|---|----|
| ● Wardrobes | 30 |
| ● Internal Accessories | 31 |
| ● External Accessories | 31 |
| ● Top Boxes | 32 |
| ● Bedside Height Base Units | 34 |
| ● Bedside Height Drawer Chests | 34 |
| ● Standard Height Base Units | 35 |
| ● Standard Height Drawerline Base Units | 37 |
| ● Standard Height Drawer Chests | 37 |
| ● Tall Drawer Chests | 38 |
| ● Miscellaneous | 38 |
| ● Accessory Drawers | 38 |
| ● Accessory Panels | 39 |

Bathroom Carcasses

40-43

Door ranges

44

Variety of applications

45

Halsted & Ward

46





basically trade®

BESPOKE KITCHEN & BEDROOM MANUFACTURER

CUSTOM-MADE CABINETS

High quality custom units produced with precision here in the UK. However bespoke your project, we can manufacture to your exact specification. We are also a very competitive supplier of standard units.

OR OFF THE SHELF OFF THE WALL

Our solutions are made for the trade.

Whether you need standard sizes or strikingly unique designs, Basically Trade will collaborate with you to enhance every last mm of storage space for your client.

Our standard units are perfect for most applications, but if your project is far from standard, we have the experience to help you solve complex issues and manufacture custom solutions for even the most bespoke projects.



It's all in the details

Drawing on years of experience in cabinet making and working with clients in varied sectors, we can help develop the best storage solution for any home or business. Basically Trade provides an impeccable finish – right down to installing pull out solutions prior to delivery. Our reputation depends on quality, so we work only with trusted partners.

Basically Trade has tackled all kinds of technical challenges, without ever compromising on quality. Basically Trade uses sustainably sourced timber to manufacture our own products right here in the UK.

Whatever style, size, colour or shape is required for your client, our precision equipment ensures a flawless finish.

Our cabinets are built to last, and designed with the fitter in mind





Celebrity designer Linda Barker's own dream kitchen

Colour-matched KITCHEN CARCASSES

Basically Trade offers made-to-measure or standard-sized kitchen carcasses made on site, right here in Lancashire.

Cabinets can be colour coded to match chosen doors and plinths, along with 2mm PVC edging tapes, so your project has a perfect finish throughout. Cabinets are manufactured in MFC (which can be colour coordinate), Plywood, Veneered MDF and paintable MDF. Unless otherwise specified, Blum fittings and drawer boxes are used as standard which come with a lifetime guarantee.

To save valuable time during installation, we can supply drawer and wall units fully assembled using rigid cam and dowel construction. Base units have adjustable height legs, and wall units are fitted with adjustable brackets.

All cabinets are supplied assembled apart from wardrobes. Kitchen and bathroom base units have adjustable legs, bedroom cabinets have gables to the floor, with side levellers.



Celebrity designer Linda Barker

eschewed big brand names to work with Basically Trade on her own dream kitchen:

“ I had a very specific idea in mind, and I needed a company that could bring the design to life without compromise. I would thoroughly recommend Basically Trade to any designer or architect, because they made it so simple and straightforward to accommodate new ideas. ”



Hiline Base Units

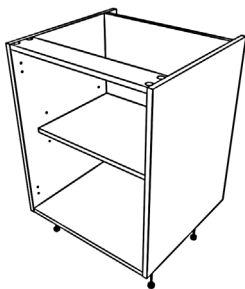

FULL HEIGHT BASE UNIT

Code: **KHB15 - KHB6**

Width (mm): 150 - 600

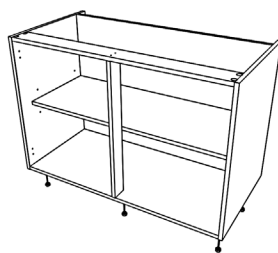

DOUBLE FULL HEIGHT
BASE UNIT

Code: **KHB6T - KHB12**

Width (mm): 600 - 1200

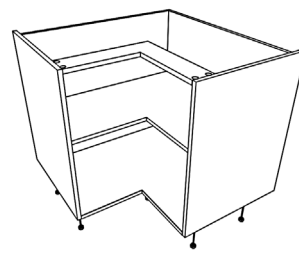

FULL HEIGHT 900
CORNER L-SHAPE BASE UNIT
330 x 330 front cut outs
4 x 170 degree hinges

Code: **KHLCB**

Width (mm): 900 x 900

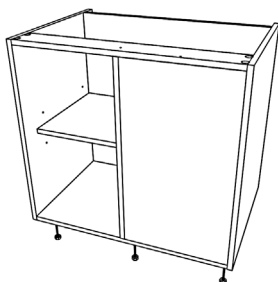

FULL HEIGHT CORNER BASE
UNIT WITH BLANKING PANEL

Code: **KHCB83 - KHCB116**

Width (mm): 800 - 1100



FULL HEIGHT CORNER BASE
UNIT WITH BLANKING PANEL
To take a pair of doors

Code: **KHCBT116 - KHCBT1512**

Width (mm): 1100 - 1500

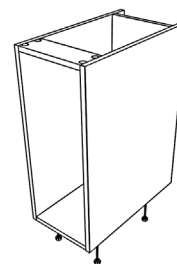

BASE UNIT TRAY SPACE
Please state size when ordering

Code: **KTS3**

Width (mm): up to 300

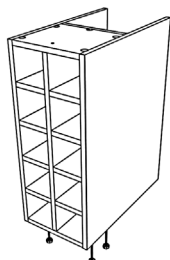

BASE WINE RACK
WITH LEGS

Code: **KBWR15 - KBWR5**

Width (mm): 150 / 300 / 500

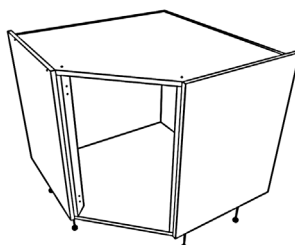

CORNER DIAGONAL BASE UNIT
To take a 450 door

Code: **KDHCB**

Width (mm): 900 x 900

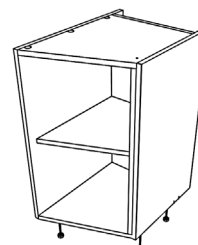

SPLAYED ANGLE BASE UNIT

Code: **KAHB3 - KAHB4**

Width (mm): 300 - 400

Drawerline Base Units (870 high inc legs)



BASE DRAWERLINE UNIT
To take one door and one drawer

Code: **KDB3 - KDB6**

Width (mm): 300 - 600



BASE DRAWERLINE UNIT
To take two doors and two drawers

Code: **KDBT6 - KDB12**

Width (mm): 600 - 1200



DRAWERLINE L-SHAPE BASE UNIT
To take two doors & dummy drawers strapped together

Code: **KDLCB**

Width (mm): 900 X 900



DRAWERLINE CORNER BASE UNIT
With blanking panel to take one door and one drawer

Code: **KDCB83 - KDCB116**

Width (mm): 800 - 1100

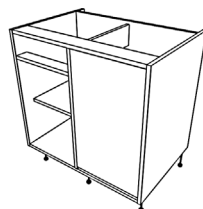

DRAWERLINE CORNER BASE UNIT
With blanking panel to take one door and one dummy drawer.

Code: **KDDCB104 - KDDCB116**

Width (mm): 1000 x 1100

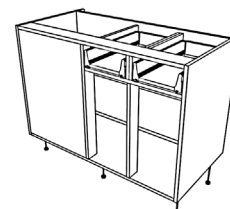

DRAWERLINE CORNER BASE UNIT
With blanking panel to take two doors and two drawers

Code: **KDCBT116 - DCBT1512**

Width (mm): 1100 x 1500

We install FOC pull outs/ wirework and bins

Designed with the fitter in mind



BESPOKE DESIGN SERVICE.



Drawerline Base Units (870 high inc legs)

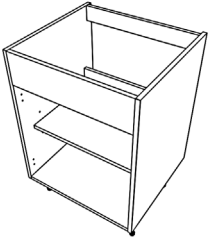

DRAWERLINE SINK BASE UNIT

To take one door and one dummy drawer

Code: **KDSB5 - KDSB6**

Width (mm): 500 - 600

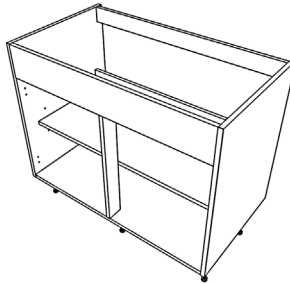

DRAWERLINE SINK BASE UNIT

To take two doors and two dummy drawers

Code: **KDSB7 - DSB12**

Width (mm): 700 - 1200



DRAWERLINE CORNER BASE UNIT

To take dummy drawer or working drawer with door

Code: **K1DSB8 - K1DSB12**

Width (mm): 800 - 1200

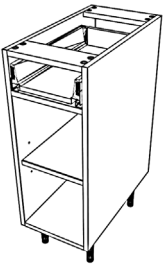

PENINSULAR BASE UNIT

Working drawer(s) on one side only

Code: **KPDB3 - KPDB12**

Width (mm): 300 - 1200

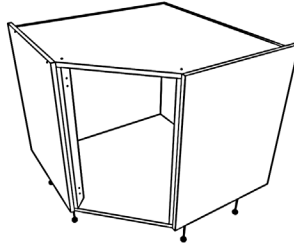

CORNER DIAGONAL BASE UNIT

To take a 450 door and dummy drawer strapped together

Code: **KDDCB**

Width (mm): 900 x 900



OPEN DRAWERLINE BASE UNIT

For wicker baskets

Code: **KODB5 - KODB6**

Width (mm): 500 - 600

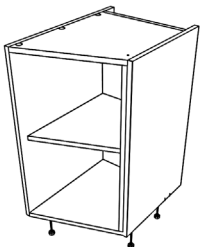

ANGLED BASE UNIT

To take a door and dummy drawer strapped together

Code: **KADB3 - KADB4**

Width (mm): 300 - 400



○ Drawer Base Units (870 high inc legs)



5 DRAWER BASE UNIT
5 x 140 drawers

Code: **K5DP3 - K5DP6**

Width (mm): 300 - 600



4 DRAWER BASE UNIT
4 x 175 drawers

Code: **K4DP3 - 4DP6**

Width (mm): 300 - 600



3 DRAWER BASE UNIT
1 x 140 drawer, 2 x 283 drawers

Code: **K3PD4 - K3PD10**

Width (mm): 400 - 1000

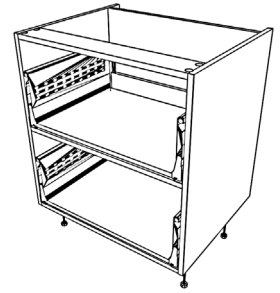

2 DRAWER BASE UNIT
2 x 355 drawers

Code: **K2PD4 - K2PD10**

Width (mm): 400 - 1000

● Low Level Base Units (725 high inc legs)

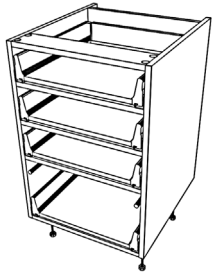

4 DRAWER BASE UNIT
3 x 140 drawers, 1 x 283 drawer

Code: **K4PD4 - K4PD10**

Width (mm): 400 - 1000

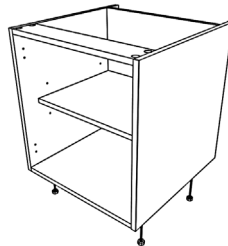

LOW LEVEL BASE UNIT

Code: **KLHB3 - KLHB6**

Width (mm): 300 - 600

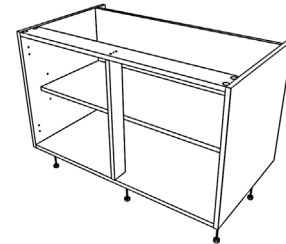

LOW LEVEL DOUBLE BASE UNIT

Code: **KLHB7 - KLHB12**

Width (mm): 700 - 1200



Oven and Microwave Base Units (870 high inc legs)

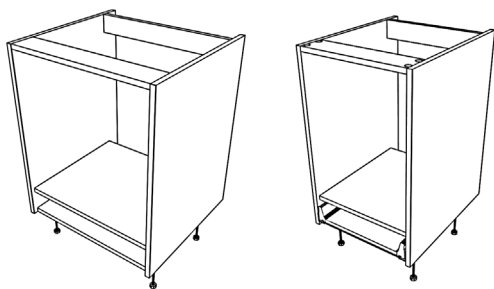

BUILT UNDER OVEN HOUSING
Fixed fascia / working drawer

Code: **KBON1 / KBON2**

Width (mm): 600

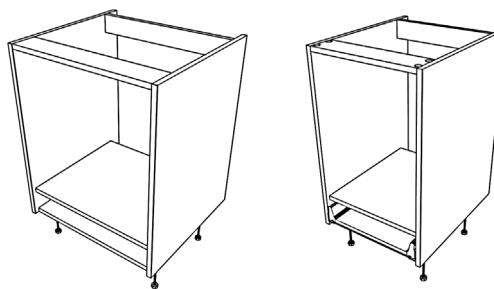

BUILT UNDER OVEN HOUSING
Fixed fascia / working drawer

Code: **KBON3 / KBON4**

Width (mm): 900

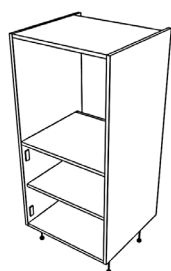

CONTINENTAL OVEN HOUSING
Door
Height: 885

Code: **KCOH1**

Width (mm): 600

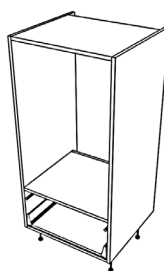

CONTINENTAL OVEN HOUSING
Working drawer
Height: 1185

Code: **KCOH9**

Width (mm): 600

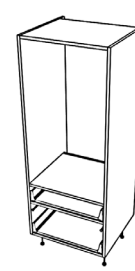

CONTINENTAL OVEN HOUSING
Working drawers
Height: 1475

Code: **KCOH10**

Width (mm): 600

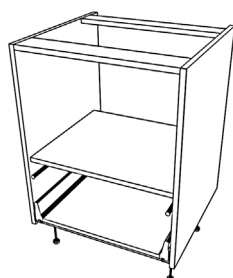

BUILT UNDER MICROWAVE HOUSING 283 drawer / 355 drawer

Code: **KBMN1 / KBMN2**

Width (mm): 600

Belfast Sink Base Units (height as specified)

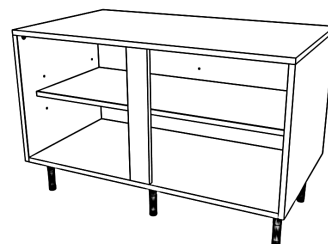
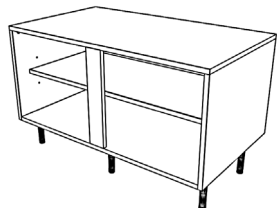

BELFAST SINK BASE UNIT
With full MFC top - 650 high (inc legs)

Code: **KBB6 - KBB9**

Width (mm): 600 / 900

BELFAST SINK BASE UNIT
With full MFC top - 500 high (inc legs)

Code: **KTBB6 - KTBB9**

Width (mm): 600 / 900

Base Open Units (870 high inc legs)

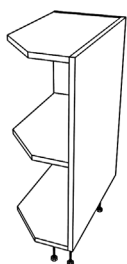

BASE OPEN END UNIT

Code: **KBES**

Width (mm): 300

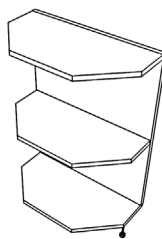

BASE OPEN PENINSULAR UNIT

Code: **KPES**

Width (mm): 300

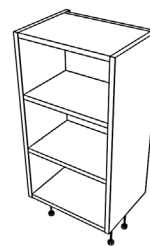

BASE OPEN SHELF UNIT
300 deep

Code: **KOHB15 - KOHB6**

Width (mm): 150 - 600

Base Tall Open Units (height as specified)

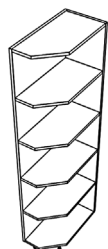

OPEN END UNIT

To suit low wall units, 1970 high (inc legs)

Code: **KSES**

Width (mm): 300

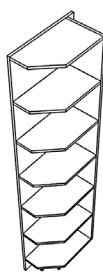

OPEN END UNIT

To suit med wall units, 2120 high (inc legs)

Code: **KMES**

Width (mm): 300



OPEN END UNIT

To suit tall wall units, 2300 high (inc legs)

Code: **KTES**

Width (mm): 300

Small Wall Units (575 high)

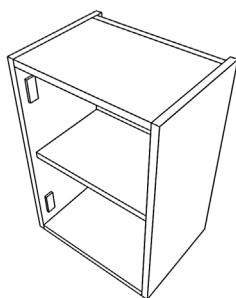

SMALL WALL UNIT

Single

Code: **KSW3 - KSW6**

Width (mm): 300 - 600

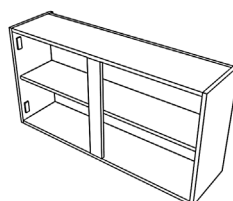

SMALL WALL UNIT

Double doors

Code: **KSW6T - KSW12**

Width (mm): 600 - 1200

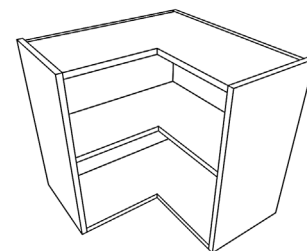

SMALL L-SHAPE CORNER WALL UNIT

300 x 300 opening for fascias

Code: **KSLCW**

Width (mm): 600 x 600

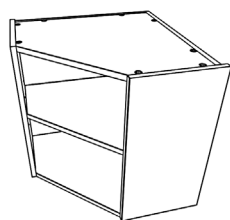

SMALL ANGLED CORNER WALL UNIT

Code: **KSACW**

Width (mm): 600 x 600

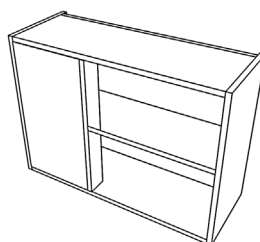

SMALL STANDARD CORNER WALL UNIT with a 300 blanking panel

Code: **KSCW63 - KSCW96**

Width (mm): 600 - 900

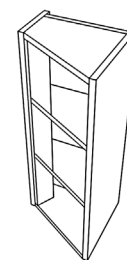

ANGLED SMALL WALL UNIT

Code: **KASW3 - KASW4**

Width (mm): 300 - 400

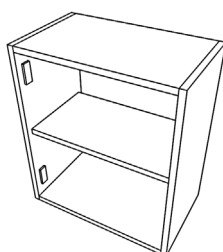

SMALL PENINSULAR WALL UNIT

Code: **KPSW3 - KPSW6**

Width (mm): 300 - 600

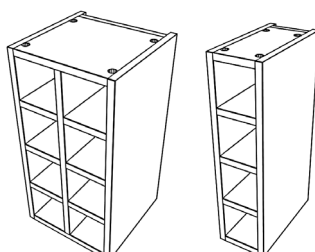

SMALL WINE RACK
300 deep

Code: **KSWR15 - KSWR3**

Width (mm): 150 / 300

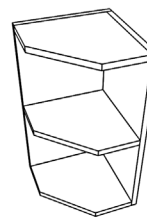

SMALL WALL END SHELF

Code: **KSWES**

Width (mm): 300

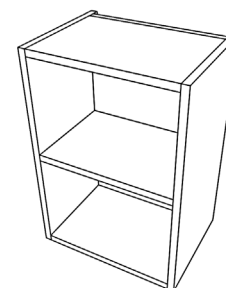

SMALL WALL OPEN SHELF UNIT

Code: **KOSW3 - KOSW10**

Width (mm): 300 - 1000

basically trade®

BESPOKE KITCHEN & BEDROOM MANUFACTURER



HALSTED & WARD



HALSTED & WARD

Medium Wall Units (720 high)

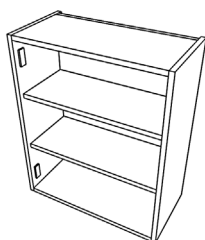

MEDIUM WALL UNIT

Single

Code: **KMW3 - KMW6**

Width (mm): 300 - 600

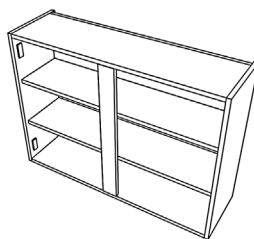

MEDIUM WALL UNIT

Double doors

Code: **KMW6T - KMW12**

Width (mm): 600 - 1200

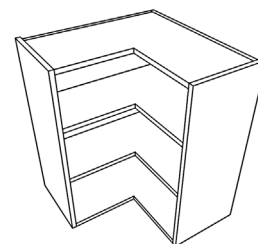

MEDIUM L-SHAPED CORNER

WALL UNIT 300 x 300 opening for fascias

Code: **KMLCW**

Width (mm): 600 x 600

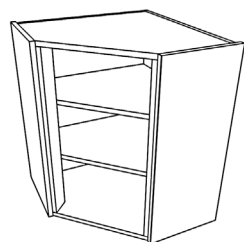

MEDIUM ANGLED
CORNER WALL UNIT

Code: **KMACW**

Width (mm): 600 x 600

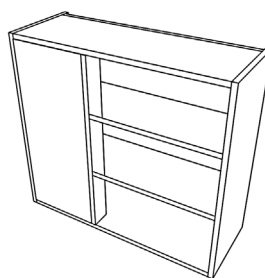

MEDIUM STANDARD CORNER
WALL UNIT with a 300 blanking panel

Code: **KMCW63 - KMCW96**

Width (mm): 600 - 900

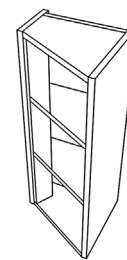

ANGLED MEDIUM WALL UNIT

Code: **KAMW3 - KAMW4**

Width (mm): 300 - 400



MEDIUM PENINSULAR
WALL UNIT

Code: **KPMW3 - KPMW6**

Width (mm): 300 - 600

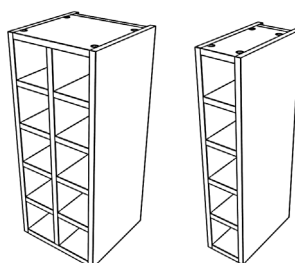

MEDIUM WINE RACK
300 deep

Code: **KMWR15 - KMWR3**

Width (mm): 150 - 300

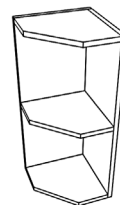

MEDIUM WALL
END SHELF

Code: **KMWES**

Width (mm): 300

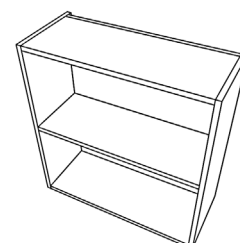

MEDIUM WALL OPEN
SHELF UNIT

Code: **KOMW3 - KOMW10**

Width (mm): 300 - 1000

Tall Wall Units (900 high)

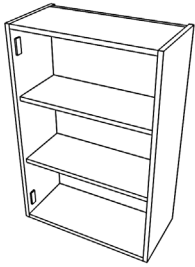

TALL WALL UNIT
Single

Code: **KTW3 - KTW6**

Width (mm): 300 - 600



TALL WALL UNIT
Double doors

Code: **KTW6T - TW12**

Width (mm): 600 - 1200

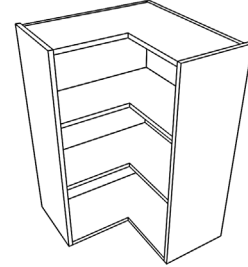

TALL L-SHAPED CORNER WALL UNIT
300 x 300 opening for fascias

Code: **KTLCW**

Width (mm): 600 x 600



TALL ANGLED CORNER
WALL UNIT

Code: **KTACW**

Width (mm): 600 x 600



TALL STANDARD CORNER
WALL UNIT with a 300 blanking panel

Code: **KTCW63 - KTCW96**

Width (mm): 600 - 900

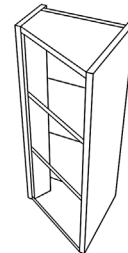

ANGLED TALL
WALL UNIT

Code: **KATW3 - KATW4**

Width (mm): 300 - 400



TALL PENINSULAR
WALL UNIT

Code: **KPTW3 - KPTW6**

Width (mm): 300 - 600

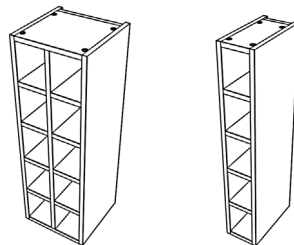

TALL WINE RACK
300 deep

Code: **KTWR15 - KTWR3**

Width (mm): 150 / 300



TALL WALL
END SHELF

Code: **KTWES**

Width (mm): 300

Top Boxes (height as specified)

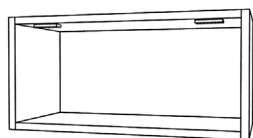

SMALL SINGLE TOP BOX
288 high

Code: **KSTB4 - KSTB6**

Width (mm): 400 - 600

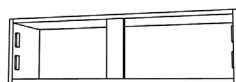

SMALL DOUBLE TOP BOX
288 high

Code: **KSTB8 - KSTB12**

Width (mm): 800 - 1200

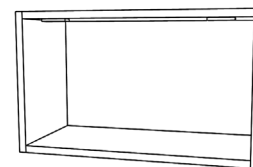

MEDIUM SINGLE TOP BOX
360 high

Code: **KMTB4 - KMTB8**

Width (mm): 400 - 600

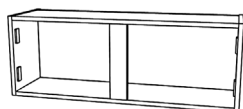

MEDIUM DOUBLE TOP BOX
360 high

Code: **KMTB10 - KMTB12**

Width (mm): 800 - 1200

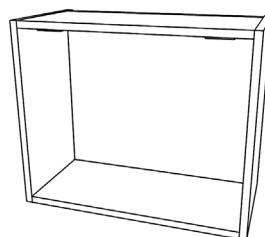

TALL SINGLE TOP BOX
495 high

Code: **KTTB5 - KTTB6**

Width (mm): 400 - 600

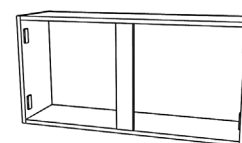

TALL DOUBLE TOP BOX
495 high

Code: **KTTB8 - KTTB12**

Width (mm): 800 - 1200



DRESSER
1065 high to take 1060 door

Code: **KSD5 - KSD6**

Width (mm): 500 - 600



DRESSER to take 895 door,
160 drawer

Code: **KSD51 - KSD61**

Width (mm): 500 - 600



DRESSER to take 715 door,
140 drawer, 195 drawer

Code: **KSD52 - KSD62**

Width (mm): 500 - 600

Small Dressers (1065 high)

Kitchen Carcasses

Medium Dressers (1210 high)



DRESSER To take 1205 door

Code: **KMD5 - KMD6**

Width (mm): 500 - 600



DRESSER To take 1060 door,
140 drawer

Code: **KMD51 - KMD61**

Width (mm): 500 - 600



DRESSER To take 915 door,
2 x 140 drawers

Code: **KMD52 - KMD62**

Width (mm): 500 - 600

Tall Dressers (1390 high)



DRESSER To take 1060 door,
140 drawer, 175 drawer

Code: **KTD52 - KTD62**

Width (mm): 500 - 600



DRESSER To take 895 door,
2 x 140 drawers, 1 x 195 drawer

Code: **KTD53 - KTD63**

Width (mm): 500 - 600

Fridge / Freezer Housings (height 1970 – 2300)

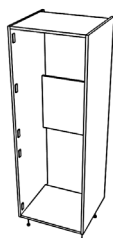

FRIDGE / FREEZER HOUSING

To take 2 x doors 1800 appliance aperture

Code: **KSFH1, KMFH1, KTFH1, KTFH1B**

Width (mm): 600



FRIDGE / FREEZER HOUSING

To take 2 x doors, 2 x 900 appliance apertures

Code: **KSFH2, KMFH2, KTFH2**

Width (mm): 600

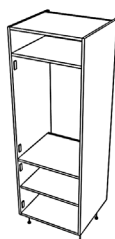

FRIDGE / FREEZER HOUSING

To take 3 x doors, 900 appliance aperture

Code: **KSFH3, KMFH3, KTFH3**

Width (mm): 600

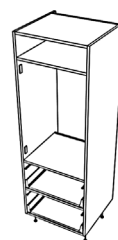

FRIDGE / FREEZER HOUSING

To take 2 x doors, 2 x drawers, 900 appliance aperture

Code: **KSFH4, KMFH4, KTFH4**

Width (mm): 600



FRIDGE / FREEZER HOUSING

To take 2 x doors, 1 x drawer, 1245 appliance aperture

Code: **KSFH5, KMFH5, KTFH5**

Width (mm): 600

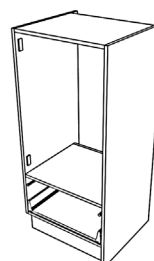

CONTINENTAL FRIDGE / FREEZER HOUSING

To take 1 door, 1 drawer, 900 appliance

Code: **KCFH1 - KCFH2**

Width (mm): 600

Oven Housings (1970 – 2300 high inc legs)

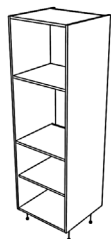

SINGLE OVEN HOUSING
600 appliance. To take 2 doors

Code: **KSOH1, KMOH1, KTOH1**

Width (mm): 600

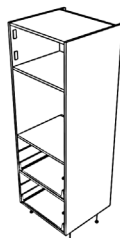

SINGLE OVEN HOUSING
600 appliance. To take 1 door, 2 drawers

Code: **KSOH2, KMOH2, KTOH2**

Width (mm): 600



SINGLE OVEN HOUSING
600 appliance. To take 2 doors, 1 drawer

Code: **KSOH3, KMOH3, KTOH3**

Width (mm): 600

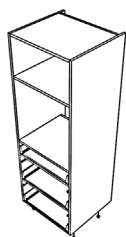

SINGLE OVEN HOUSING
600 appliance. To take 1 door, 3 drawers

Code: **KSOH4, KMOH4, KTOH4**

Width (mm): 600

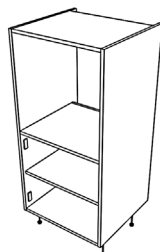

CONTINENTAL DOUBLE OVEN HOUSING
900 appliance. To take 1 door
Height 1035 - 1335

Code: **KCOH1 - KCOH4**

Width (mm): 600



CONTINENTAL OVEN HOUSING
900 appliance. Height 1035 – 1335
To take 2 drawers

Code: **KCOH5 - KCOH12**

Width (mm): 600

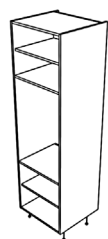

DOUBLE OVEN HOUSING
900 appliance. To take 2 doors

Code: **KSOH5, KMOH5, KTOH5**

Width (mm): 600



DOUBLE OVEN HOUSING
900 appliance. To take 1 door, 2 drawers

Code: **KSOH6, KMOH6, KTOH6**

Width (mm): 600

Oven Housings (1970 – 2300 high inc legs)

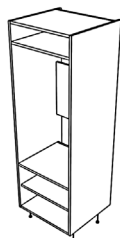

SINGLE OVEN & MICROWAVE HOUSING To take 2 doors

Code: **KSOH8, KMOH8, KTOH8**

Width (mm): 600

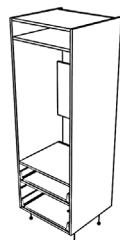

SINGLE OVEN & MICROWAVE HOUSING To take 1 door, 2 drawers

Code: **KSOH9, KMOH9, KTOH9**

Width (mm): 600

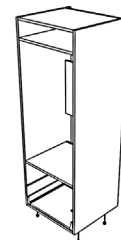

SINGLE OVEN & MICROWAVE HOUSING To take 1 door, 1 drawer

Code: **KSOH7, KMOH7, KTOH7**

Width (mm): 600

Miscellaneous Tall Units (1970 – 2300 high inc legs)

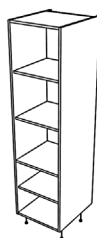

LARDER UNIT

To take 2 doors

Code: **KSL3-6, KML3-6, KTL3-6**

Width (mm): 300 – 600



BROOM UNIT

To take 2 doors

Code: **KSB3-6, KMB3-6, KTB3-6**

Width (mm): 300 – 600

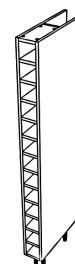

WINE RACK

Code: **SWR**

Width (mm): 150 / 300

HANDLELESS KITCHENS

Our premium range of bespoke kitchens all manufactured in the UK. All designed to your exact specification. Call today to learn more.



Accessory Panels



PLINTH

Code: **KPMFC**

Width (mm): 2600 x 150



END PANEL

Code: **SWEP - XTEP**

Height (mm): 575 - 2600



BASE & WALL FILLER

100 wide

Code: **KF1 - KF7**

Height (mm): 575 - 2600

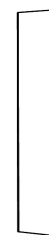

BASE & WALL FILLER

200 wide

Code: **KF8 - KF14**

Height (mm): 575 - 2600



SHOWBACK PANEL

900 high

Code: **KBP12 - KBP26**

Height (mm): 1200 - 2000

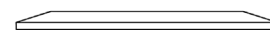

FLYOVER SHELF

Code: **KFO3 - KFO45**

Width (mm): 300 - 450







BEAUTIFULLY BESPOKE **BEDROOM STORAGE**

We can help you create a haven of calm and organisation for your clients.

Whether they're hanging designer dresses, or storing stacks of socks - we can work with you to create the perfect wardrobe space. However awkward the space, we can help. Talk to us about options like different depth drawers or sloped-back storage.

As you'd expect, all cabinets are colour coded throughout to match the doors, and Blum fittings are used as standard. To save time during installation, robes are supplied flat packed for easy manoeuvrability while drawer units and top boxes are provided fully assembled.

Basically Trade is committed to quality and all the units we manufacture are 18mm throughout, including backs and drawer boxes.

Don't forget the details: we can offer clear-lacquered, solid timber dovetailed drawer boxes in timbers such as Birch Plywood, Oak, Walnut, Beech and Maple, pull down hanging rails, trouser and tie storage and shoe storage.

** Prices on quotation basis*

Bedroom Carcasses

Wardrobes (2260 high)



STANDARD SINGLE ROBE
1 hanger

Code: **BR3 - BR6**

Width (mm): 300 - 600

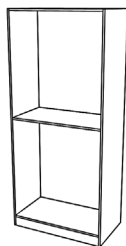

STANDARD DOUBLE ROBE
1 hanger (shown as double hanging)

Code: **BR6T - BR12**

Width (mm): 600 - 1200



STANDARD CORNER ROBE
Including 500 blanking panel

Code: **BCR35 - BCR6**

Width (mm): 850 - 1100

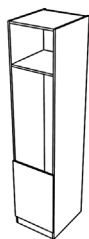

SINGLE STABLE ROBE

Code: **BSR5 - BSR6**

Width (mm): 500 - 600

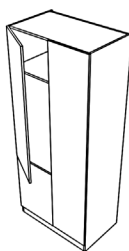

DOUBLE STABLE ROBE

Code: **BSR9 - BSR10**

Width (mm): 900 - 1000



CORNER DIAGONAL ROBE
1 curved hanger

Code: **BDR4 - BDR65**

Width (mm): Back width in both directions 870 - 1050

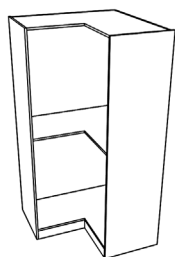

L-SHAPE CORNER ROBE
Curved hanger (shown as double hanging)

Code: **BLCR3 - BLCR5**

Width (mm): back width 870 x 890,
970 x 990, 1070 x 1090



SINGLE COMBINATION LINEN ROBE
1495 high doors, 3 x 215 drawers

Code: **BLR3 - BLR6**

Width (mm): 300 - 600

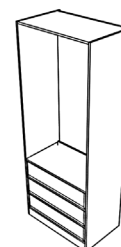

DOUBLE COMBINATION LINEN ROBE
1495 high doors, 3 x 215 drawers

Code: **BLR7 - BLR10**

Width (mm): 700 - 1000

Internal Accessories

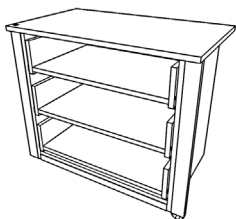

SINGLE INTERNAL CHEST
Including MFC worktop

Code: **BIC4 - BIC6**

Width (mm): 400 - 600

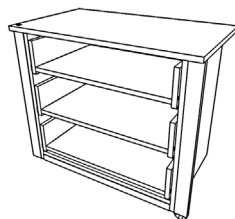

DOUBLE INTERNAL CHEST
Including MFC worktop

Code: **BIC7 - BIC10**

Width (mm): 700 - 1000

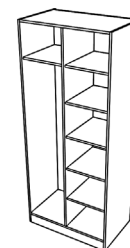

INTERNAL ROBE PACK
1 divider, 5 shelves, 1 rail

Code: **BRP6 - BRP12**

Width (mm): 600 - 1200

External Accessories

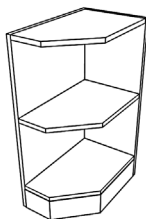

RH / LH BASE END SHELF
760 high inc 100 plinth

Code: **BBESR3 / BBESL3**

Width (mm): 300



RH / LH TALL END SHELF
2260 high inc 100 plinth

Code: **BTESR3 / BTESL3**

Width (mm): 300



36mm worktops and shelves

Bedroom Carcasses

Top Boxes (height as stated)

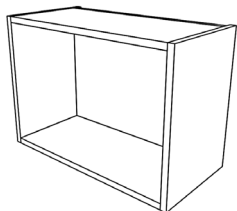

SINGLE TOP BOX

420 high, 415 high door

Code: **BBSTB3 - BBSTB6**

Width (mm): 300 - 600

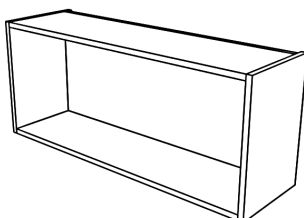

DOUBLE TOP BOX

420 high, 415 high door

Code: **BBSTB7 - BBSTB12**

Width (mm): 700 - 1200

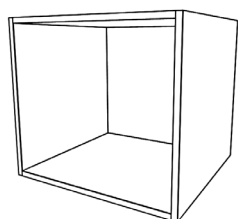

SINGLE TOP BOX

540 high, 535 high door

Code: **BBTTB3 - BBTTB6**

Width (mm): 300 - 600

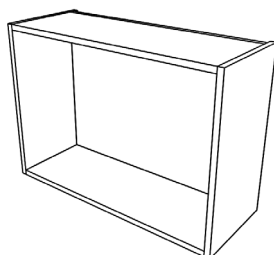

DOUBLE TOP BOX

540 high, 535 high door

Code: **BBTTB7 - BBTTB12**

Width (mm): 700 - 1200

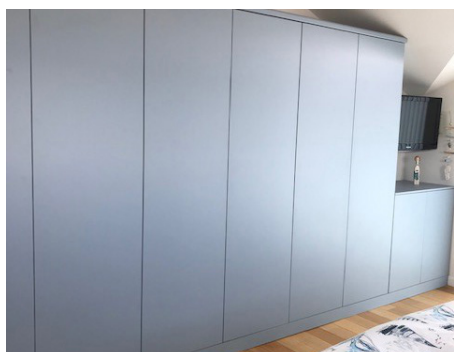



HALSTED & WARD

H&W Bedroom furniture painted in F&B Stiffkey Blue 25% sheen



Bedroom Carcasses

Bedside Height Base Units (640 high)

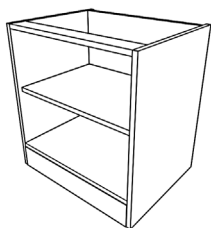

BEDSIDE SINGLE CABINET

535 high door

Code: **BBC3 - BBC6**

Width (mm): 300 - 600

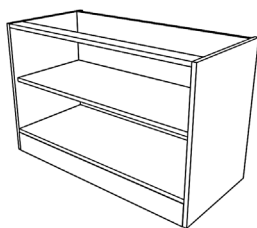

BEDSIDE DOUBLE CABINET

535 high doors

Code: **BBC6T - BBC12**

Width (mm): 600 - 1200

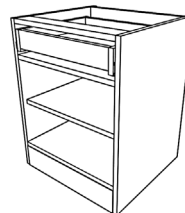

BEDSIDE SINGLE DRAWERLINE BASE UNIT

390 high door, 140 drawer

Code: **BBDB3B - BBDB6B**

Width (mm): 300 - 600



BEDSIDE DOUBLE DRAWERLINE BASE UNIT

390 high doors, 140 drawers

Code: **BBDB6TB - BBDB10B**

Width (mm): 600 - 1000



BEDSIDE SINGLE DRAWERLINE BASE UNIT

415 high door, 115 drawer

Code: **BBDB3 - BBDB6**

Width (mm): 300 - 600



BEDSIDE DOUBLE DRAWERLINE BASE UNIT

415 high doors, 115 drawers

Code: **BDR4 - BDR65**

Width (mm): 600 - 1000

Bedside Height Drawer Chests (640 high)

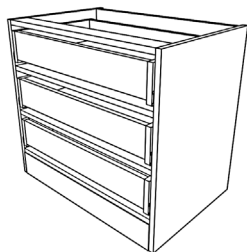

BEDSIDE 3 DRAWER CHEST

3 x 175 drawers

Code: **BB3D3 - BB3D10**

Width (mm): 300 - 1000

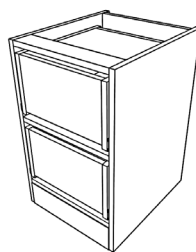

BEDSIDE 2 DRAWER CHEST

2 x 265 drawers

Code: **BB2D3 - BB2D10**

Width (mm): 300 - 1000

Standard Height Base Units (760 high)



STANDARD HEIGHT SINGLE BASE UNIT

655 high door

Code: **BSHB3 - BSHB6**

Width (mm): 300 - 600



STANDARD HEIGHT DOUBLE BASE UNIT

655 high doors

Code: **BSHB6T - BSHB12**

Width (mm): 600 - 1200

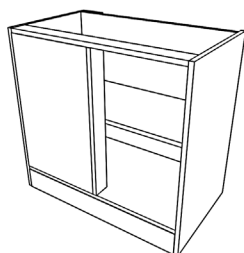

STANDARD HEIGHT CORNER BASE UNIT

655 high door including
400 blanking panel

Code: **BSHCB35 - BSHCB6**

Width (mm): 750 - 1200

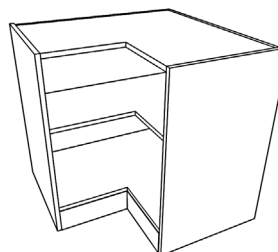

STANDARD HEIGHT L-SHAPE CORNER

655 high doors

Code: **BSHLCB**

Width (mm): 770 x 790

Bedroom Carcasses



Our PVC edged and veneered fronts are book matched grain.



Standard Height Drawerline Base Units (760 high)



STANDARD HEIGHT SINGLE DRAWERLINE BASE UNIT

510 high door, 140 drawer

Code: **BSDB3B - BSDB6B**

Width (mm): 300 - 600



STANDARD HEIGHT DOUBLE DRAWERLINE BASE UNIT

510 high door, 140 drawer

Code: **BSDB6TB - BSDB10B**

Width (mm): 600 - 1000



STANDARD HEIGHT SINGLE DRAWERLINE BASE UNIT

535 high door, 115 drawer

Code: **BSDB3 - BSDB6**

Width (mm): 300 - 600



STANDARD HEIGHT DOUBLE DRAWERLINE BASE UNIT

535 high door, 115 drawer

Code: **BSDB6T - BSDB10**

Width (mm): 600 - 1000

Standard Height Drawer Chests (760 high)

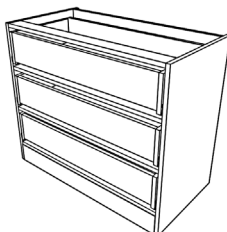

STANDARD HEIGHT 3 DRAWER CHEST

3 x 215 drawers

Code: **BS3D3 - BS3D10**

Width (mm): 300 - 1000

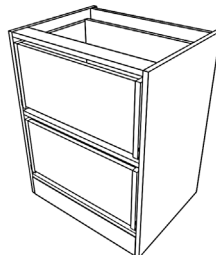

STANDARD HEIGHT 2 DRAWER CHEST

2 x 325 drawers

Code: **BS2D3 - BS2D10**

Width (mm): 300 - 1000

Bedroom Carcasses

Tall Drawer Chests (height as stated)



4 DRAWER CHEST
980 high, 4 x 215 drawers

Code: **B4D3 - B4D10**

Width (mm): 300 - 1000

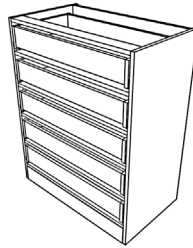

5 DRAWER CHEST
1000 high, 5 x 175 drawers

Code: **B5D3 - B5D10**

Width (mm): 300 - 1000

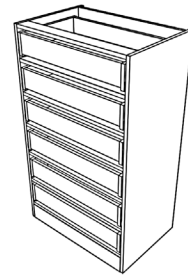

6 DRAWER CHEST
1180 high, 6 x 175 drawers

Code: **B6D4 - B6D10**

Width (mm): 400 - 1000

Miscellaneous



TV UNIT WITH 3 DRAWERS
1360 high, 715 high doors,
3 x 175 drawers

Code: **BTV8 - BTV10**

Width (mm): 800 - 1000

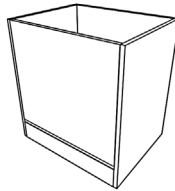

LAUNDRY CHEST
760 high, 450 wide, 450 deep

Code: **BLC**

Width (mm): 450

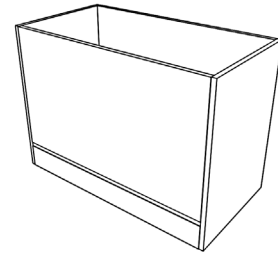

OTTOMAN
640 high, 470 deep

Code: **BO3 - BO10**

Width (mm): 300 - 1000

Accessory Drawers

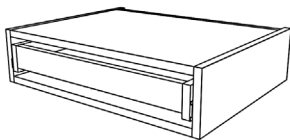

VANITY DRAWER
120 high, 115 drawer

Code: **BV5 - BV10**

Width (mm): 500 - 1000

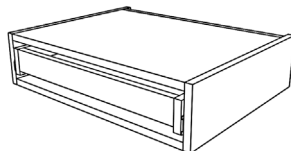

VANITY DRAWER
145 high, 140 drawer

Code: **BV5B - BV10B**

Width (mm): 500 - 1000

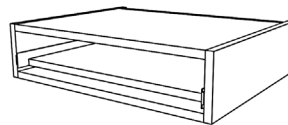

KEYBOARD DRAWER
145 high

Code: **BK5 - BK8**

Width (mm): 500 - 800



PULLOUT SHOE SHELF
18mm shelf with 75mm front/back

Code: **K5 - K10**

Width (mm): 500 - 1000

Accessory Panels

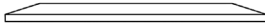

ADDITIONAL SHELF
470 deep

Code: **BS3 - BS10**

Width (mm): 300 - 1000



CEILING SCRIBING PANEL

Code: **BSP2 - BSP10**

Width (mm): 2600 x 200 - 1000



MFC PLINTH

Code: **BBPMFC**

Width (mm): 2600 x 100

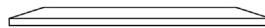

BRIDGING SCRIBE PANEL
Edged two long sides

Code: **BBSP**

Width (mm): 2600 x 570

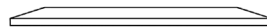

FLYOVER SHELF
2600 long

Code: **BFO15 - BFO45**

Width (mm): 150 - 450



SHOWBACK PANEL
900 high

Code: **BBP12 - BBP26**

Width (mm): 1200 - 1600

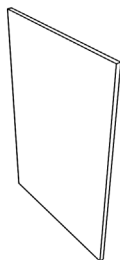

END SUPPORT PANEL
600 wide

Code: **BBEPS - XTEP**

Height (mm): 640 - 2400



BASE & WALL FILLER
100 wide

Code: **BF2 - BF7**

Height (mm): 720 - 2600



BASE & WALL FILLER
200 wide

Code: **BF9 - BF14**

Height (mm): 720 - 2600



RODRIGUES
INTERIORS

rodriguesinteriors.co.uk

TAP INTO TAILOR-MADE **BATHROOM CABINETS**

Create spa-like spaces for your clients, even where there's restricted room. Basically Trade's bathroom storage can be designed to incorporate pipes, sit under sloping eaves, and fit around bathroom suites for the best possible use of space.

It took a full five years of research and development to unveil our own signature bathroom furniture range which was designed in partnership with industry specialists to ensure it can take your project from acceptable to exceptional.

The Basically Bathrooms range is covered by our no-nonsense ten year guarantee which underlines our commitment to quality and durability. Cabinets are proudly made in Britain using sustainably grown materials.

With adjustable plinth heights from 100mm to 200mm, PVC-edged door options, and premium 6mm toughened glass shelves available, Basically Bathrooms can be designed to suit any suite.

In any finish and any colour, there are matching custom panels available, along with complementary towel rails and toilet roll holders. Pull out storage ensures that expensive cosmetics no longer get lost down the back of a conventional cabinet.



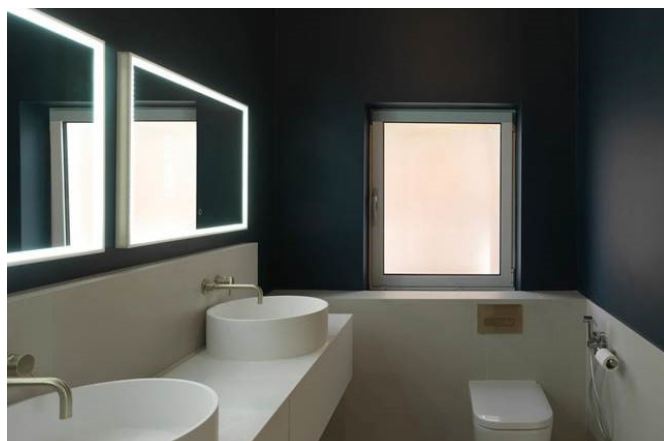

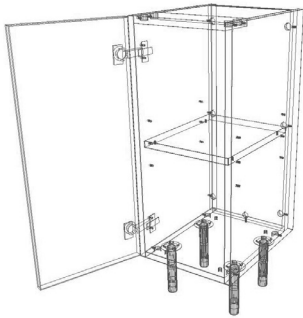

BATHROOM BASE STORAGE CABINET 150 - 300 wide

Code: **BSB015-3**

Height: 865 Depth: 335 (mm)

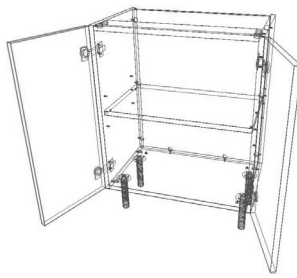

BATHROOM DOUBLE BASE UNIT

600 - 800 wide

Code: **BSB6-8**

Height: 865 Depth: 335 (mm)

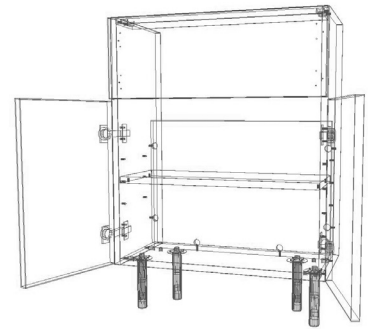

DOUBLE BASE VANITY

600 wide

Code: **BVEX6-8**

Height: 820 Depth: 420 (mm)



VANITY DOUBLE BASE UNIT 500 - 600 wide

Code: **BVAB05-06**

Height: 865 Depth: 335 (mm)

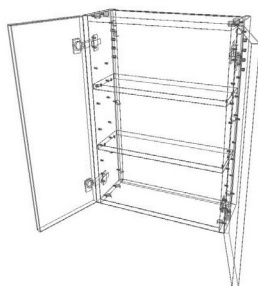

BATHROOM WALL UNIT 500 - 600 wide

Code: **BMW5-6**

Height: 700 Depth: 185 (mm)



BATHROOM WC BASE UNIT 500 - 600 wide

Code: **BWC05-6**

Height: 865 Depth: 335 (mm)

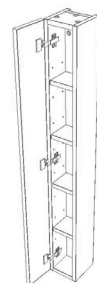

TALL BATHROOM STORAGE WALL UNIT 150 - 300 wide

Code: **BTW15-3**

Height: 1350 Depth: 150 (mm)

DOOR RANGES

The door options available from Basically Trade are limitless. We offer standard sizes in all sorts of styles, from traditional shaker, to sleek, modern handleless options in a wealth of finishes.

We can also manufacture made-to-measure doors to your exact specification.

Brands we offer are: Bella, Browns2000, PVC edged, Halsted & Ward



basically trade
BESPOKE KITCHEN & BEDROOM MANUFACTURER

HALSTED & WARD
BEAUTIFULLY BESPOKE PAINTED DOORS



Basically Trade - PVC edged



Halsted & Ward - Painted



Bella



Browns 2000

IMAGINE THAT

While kitchens, bedrooms and bathrooms are our 'bread and butter', we manufacture bespoke storage solutions for every room in the house, and for discerning businesses too.

Basically Trade has been praised for our useful utility room storage, multi-functional media rooms, home offices and even

hotel bars. We've created everything from tiny kitchen pods to expansive shop shelving, and our customers describe us as the 'go-to company for problem solving'.

The only limit is your imagination.

We can help with everything else.



HALSTED & WARD

BEAUTIFULLY BESPOKE PAINTED DOORS

Halsted and Ward is our premium range of bespoke painted panels and doors. These immaculate products are manufactured in house and are so beautifully finished that we're proud to put our family names to them.

Basically Trade is completely committed to quality and we went above and beyond in bringing this range to fruition: over a year of research and development, examining and comparing countless samples, continuous testing and re-testing of materials and finishes until we finally arrived at the perfect combination of product and paint quality needed for such a flawless finish.

We spent more than a year finding the perfect paint company – a family-run firm who are (almost) as passionate about the new Halsted & Ward range as we are.

We have in-house stock of the highest quality 22mm Fibralac MDF giving us complete control over quality and lead times on the Halsted & Ward range.

This made-to-measure range is available in absolutely any colour, and in the following styles:

- ONE-PIECE SHAKERS
your choice of rail widths
- J PULL
- FLAT SLAB
with 3mm Radiused front edges
- PANELS



10 year Carcass Guarantee

This guarantee does not apply to any parts, materials or equipment that are not supplied by Back to Basics Ltd t/a Basically Trade, nor does it apply to faults arising from incorrect design, poor planning, substandard fitting, insufficient maintenance or damage caused by water ingress.

We, Back to Basics Ltd t/a Basically Trade (The 'Seller') – Company Registration No 5504769, Unit 2, Wyre Street, Padiham, Lancashire, BB12 8DF hereby Guarantee that the Kitchen and Bedroom carcasses will be free from manufacturing defects in materials and workmanship for a period of 10 years from the date of delivery of the products, subject to the following conditions:

1. In so far as the terms of this Guarantee are inconsistent with the Seller's standard terms and conditions of sale, the contents of this Guarantee shall prevail.
2. Our Customer must notify the Seller, in writing, of the nature of the alleged defect within one month of the delivery date or (where the defect or failure was not apparent upon reasonable inspection) within 3 months after the date of discovery and within the period of this Guarantee.
3. The Seller shall not be liable for any defect on its products arising from any drawing, design or specification supplied by, or to our Customer.
4. The Seller shall not be liable for any defect arising from wilful damage, negligence, abnormal working conditions, incorrect design or fitting by our Customer or any third party other than the Seller. Neither will it be liable for our Customer's failure to follow the Seller's instructions (whether oral or in writing), misuse, alteration or repair of the products without the Seller's prior approval.
5. The Seller shall not be liable for normal product wear and tear as a result of general domestic use. Neither does this Guarantee apply to defects relating to other manufacturer's products.
6. The Seller shall not be liable under the Guarantee if the total price of the products has not been paid for by the due date for payment.
7. Where any valid claim regarding a product is agreed by the Seller and is based upon a defect in the quality or condition of the products or the Seller's failure to meet any specification, our Customer shall be entitled at their choice to have the original product repaired. If, from this, the claim cannot be resolved it will be directly replaced with the most similar product available at the time. No credit notes or cash refund will be given by the Seller; neither will it be responsible for the product installation.
8. Save for the Seller's obligations referred to in clause 7 above, the Seller shall have no further liability to our Customer and shall not be liable (save for death or personal injury) for consequential loss or damage, costs, expenses, or other claims for consequential compensation (whether caused by the negligence of the Seller, its employees, agents or otherwise) in connection with the supply of the products or their use or resale by our Customer.
9. Natural environmental changes, such as the passage of time and exposure to light, cause the colour of materials to gradually alter. Therefore if a replacement is required, it may not be possible to provide a new carcass which exactly matches the existing units. In this case, should the original material be no longer available, the Seller will endeavour to provide the closest possible alternative from the current range.
10. This Guarantee shall be governed by and construed in all respects in accordance with English Law.
11. This Guarantee is nontransferable and supersedes any previous agreement or contract, expressed or implied.
12. Your Statutory Rights are not affected by the Terms of this Guarantee.





Basically Trade

Unit 2
Wyre Street
Padiham
Lancashire
BB12 8DF

01282 816434

email: sales@basicallytrade.co.uk

www.basicallytrade.co.uk

basically trade[®]
BESPOKE KITCHEN & BEDROOM MANUFACTURER